

## DUKKABOARD SHOWER TRAYS

Document number DTD-1000	Revision 1.1
Standard Dukkaboard Tray 1000 X 800 X 20mm O/S	Product Code DS-RC-1080
To Suit Drain To suit DS-ST-0010 / DS-ST-0025	Date 07/09/2016

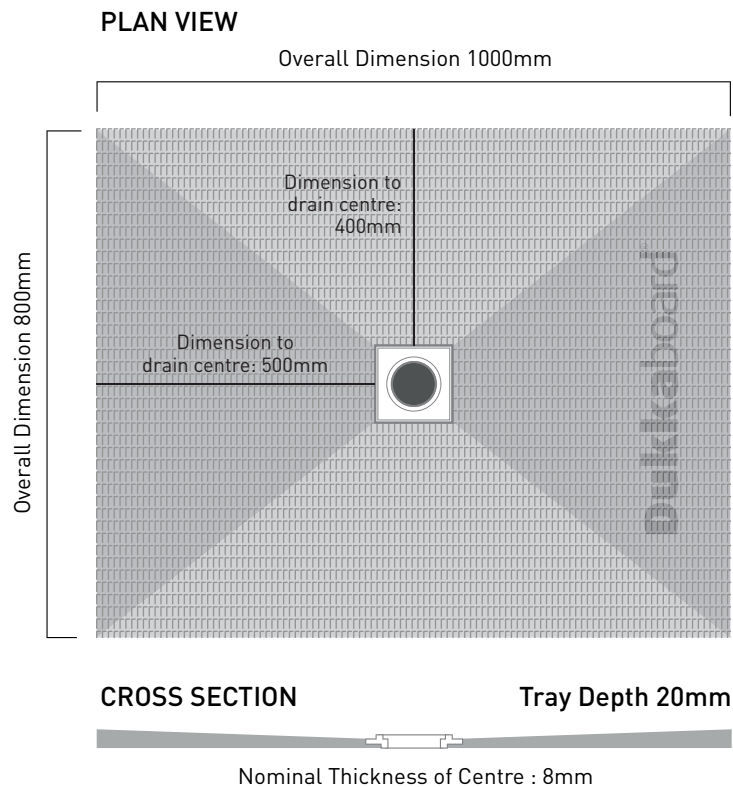

## DUKKABOARD SHOWER TRAYS

Document number DTD-1001	Revision 1.1
Standard Dukkaboard Tray 1200 X 900 X 20mm O/S	Product Code DS-RC-1290
To Suit Drain To suit DS-ST-0010 / DS-ST-0025	Date 07/09/2016

### PLAN VIEW

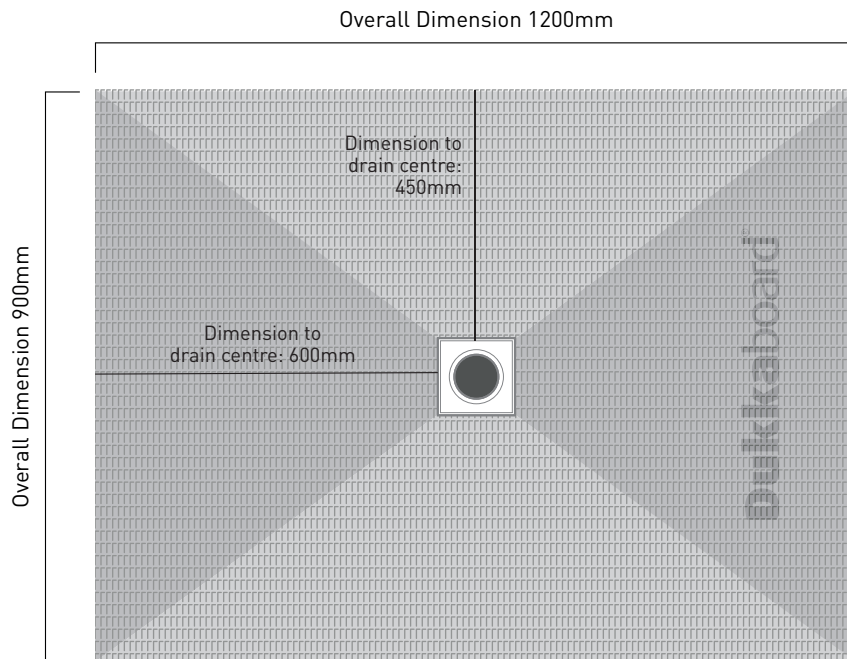

### CROSS SECTION



Nominal Thickness of Centre : 8mm

### Dukkaboard

Tel: 0870 1271 300  
Email: [info@dukkaboard.com](mailto:info@dukkaboard.com)



For technical information, support and more installation guides and videos from the expert team at Dukkaboard, visit [www.dukkaboard.com/the-knowledge-network](http://www.dukkaboard.com/the-knowledge-network)

[www.dukkaboard.com](http://www.dukkaboard.com)

# Dukkaboard®

## DUKKABOARD SHOWER TRAYS

Document number DTD-1002	Revision 1.1
Standard Dukkaboard Tray 1500 X 900 X 20mm O/S	Product Code DS-RC-1590
To Suit Drain To suit DS-ST-0010 / DS-ST-0025	Date 07/09/2016

### PLAN VIEW

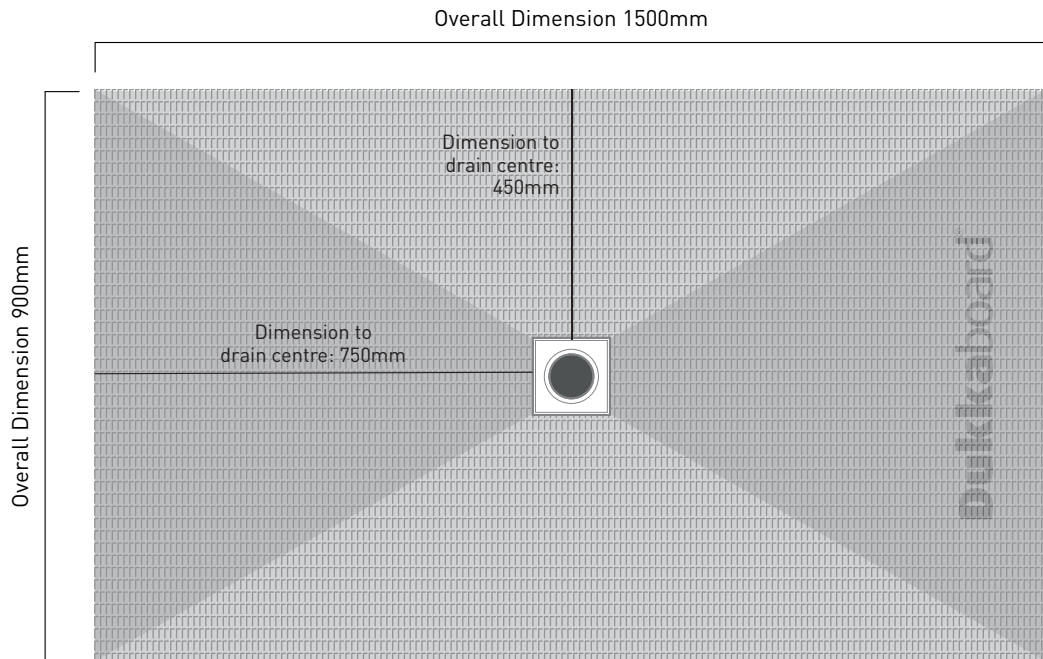

### CROSS SECTION

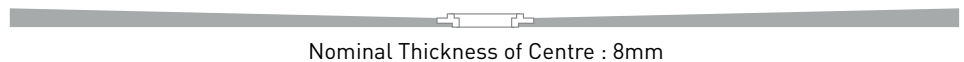

### Dukkaboard

Tel: 0870 1271 300  
 Email: [info@dukkaboard.com](mailto:info@dukkaboard.com)



For technical information, support and more installation guides and videos from the expert team at Dukkaboard, visit [www.dukkaboard.com/the-knowledge-network](http://www.dukkaboard.com/the-knowledge-network)

[www.dukkaboard.com](http://www.dukkaboard.com)

# Dukkaboard®

## DUKKABOARD SHOWER TRAYS

Document number DTD-1003	Revision 1.1
Standard Dukkaboard Tray 1830 X 915 X 25mm O/S	Product Code DS-RC-1891
To Suit Drain To suit DS-ST-0010 / DS-ST-0025	Date 07/09/2016

### PLAN VIEW

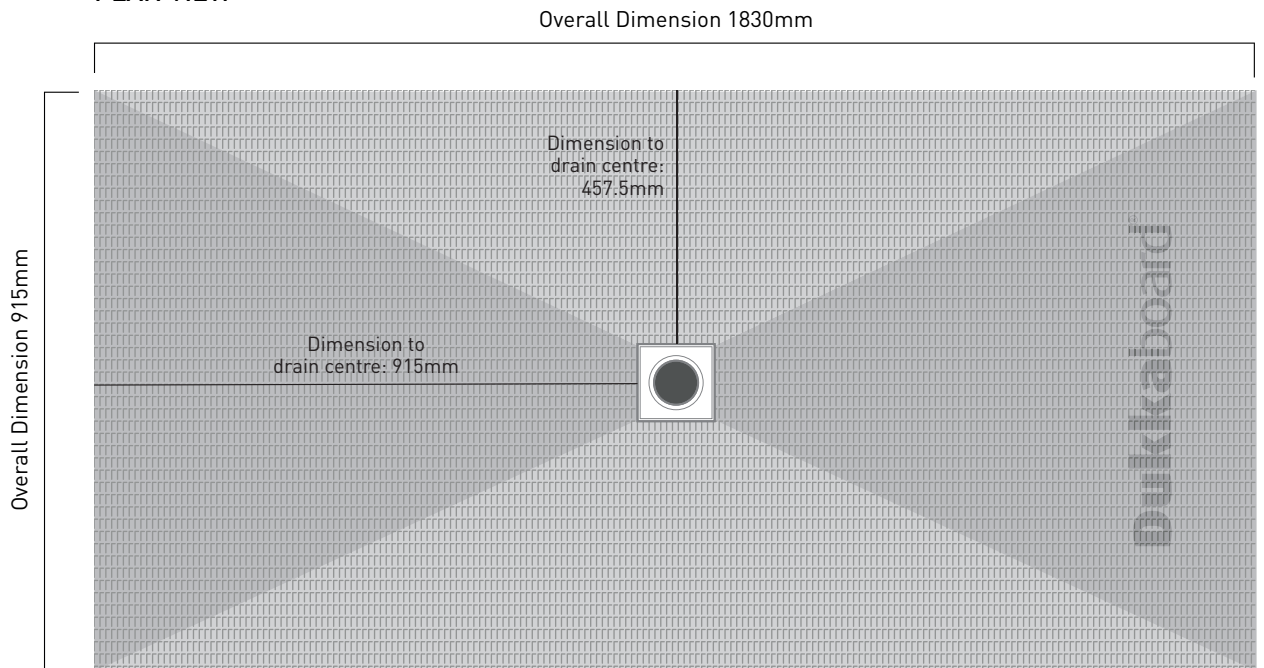

### CROSS SECTION

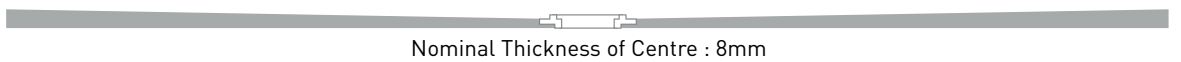

## DUKKABOARD SHOWER TRAYS

Document number DTD-1004	Revision 1.1
Standard Dukkaboard Tray 1500 X 1200 X 20mm O/S	Product Code DS-RC-1512
To Suit Drain To suit DS-ST-0010 / DS-ST-0025	Date 07/09/2016

### PLAN VIEW

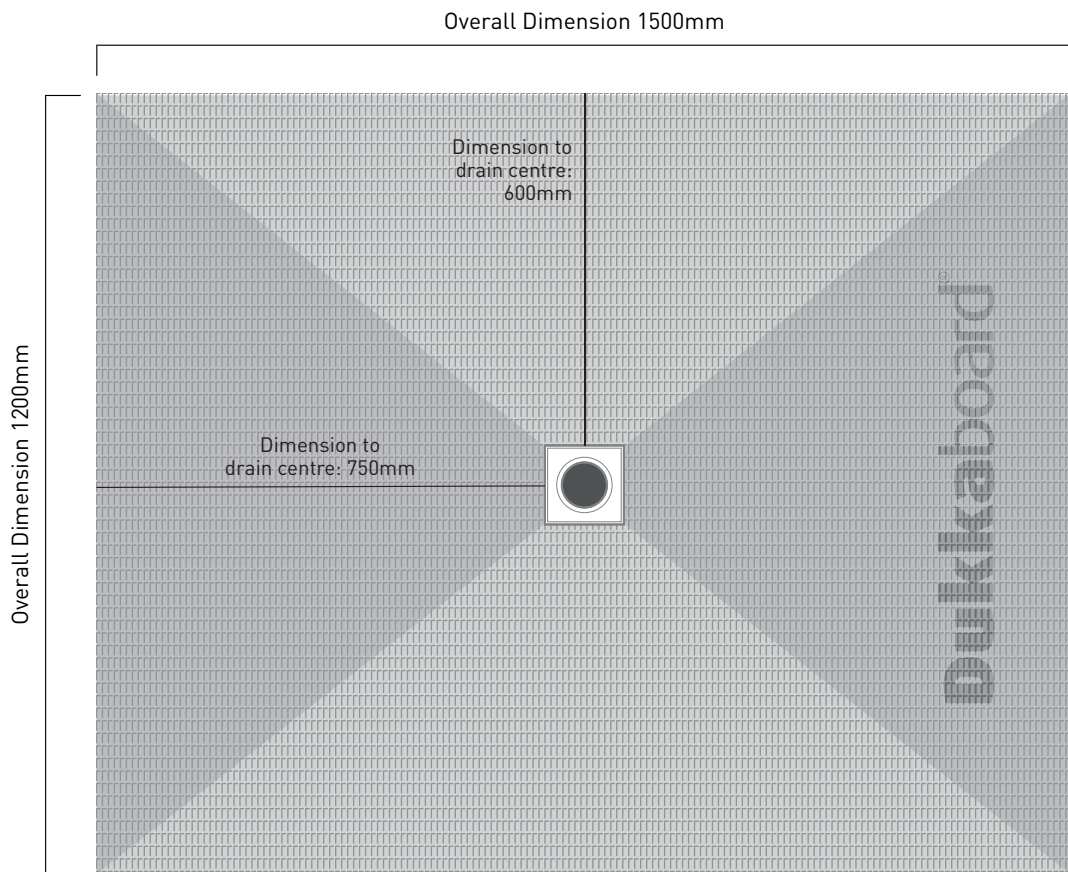

### CROSS SECTION

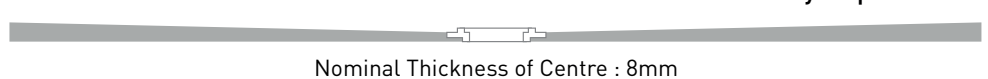

### Dukkaboard

Tel: 0870 1271 300  
 Email: [info@dukkaboard.com](mailto:info@dukkaboard.com)



For technical information, support and more installation guides and videos from the expert team at Dukkaboard, visit [www.dukkaboard.com/the-knowledge-network](http://www.dukkaboard.com/the-knowledge-network)

[www.dukkaboard.com](http://www.dukkaboard.com)

## DUKKABOARD SHOWER TRAYS

Document number DTD-1005	Revision 1.1
Standard Dukkaboard Tray 800 X 800 X 20mm O/S	Product Code DS-SC-8080
To Suit Drain To suit DS-ST-0010 / DS-ST-0025	Date 07/09/2016

### PLAN VIEW

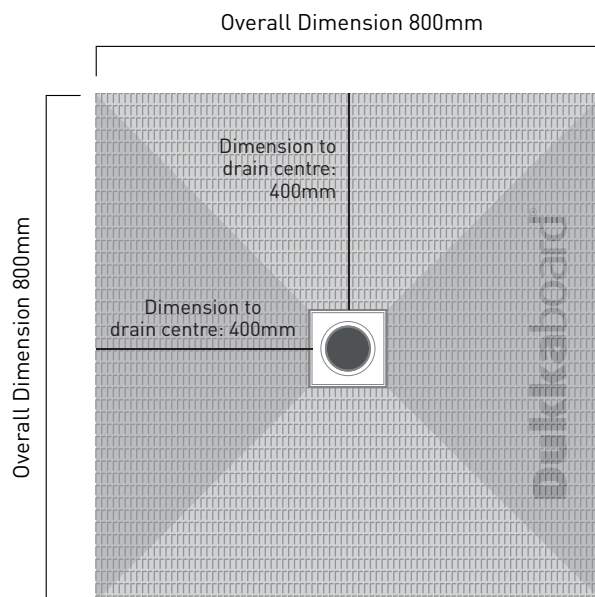

### CROSS SECTION

Tray Depth 20mm



Nominal Thickness of Centre : 8mm

### Dukkaboard

Tel: 0870 1271 300  
Email: [info@dukkaboard.com](mailto:info@dukkaboard.com)



For technical information, support and more installation guides and videos from the expert team at Dukkaboard, visit [www.dukkaboard.com/the-knowledge-network](http://www.dukkaboard.com/the-knowledge-network)

[www.dukkaboard.com](http://www.dukkaboard.com)

## DUKKABOARD SHOWER TRAYS

Document number DTD-1006	Revision 1.1
Standard Dukkaboard Tray 900 X 900 X 20mm O/S	Product Code DS-SC-9090
To Suit Drain To suit DS-ST-0010 / DS-ST-0025	Date 07/09/2016

### PLAN VIEW

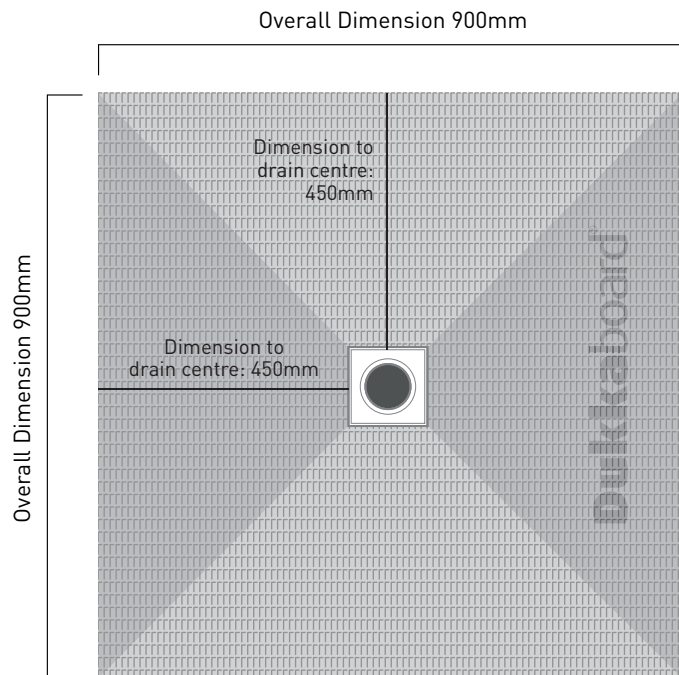

### CROSS SECTION



### Dukkaboard

Tel: 0870 1271 300  
Email: [info@dukkaboard.com](mailto:info@dukkaboard.com)



For technical information, support and more installation guides and videos from the expert team at Dukkaboard, visit [www.dukkaboard.com/the-knowledge-network](http://www.dukkaboard.com/the-knowledge-network)

[www.dukkaboard.com](http://www.dukkaboard.com)

## DUKKABOARD SHOWER TRAYS

Document number DTD-1007	Revision 1.1
Standard Dukkaboard Tray 1000 X 1000 X 20mm O/S	Product Code DS-SC-1010
To Suit Drain To suit DS-ST-0010 / DS-ST-0025	Date 07/09/2016

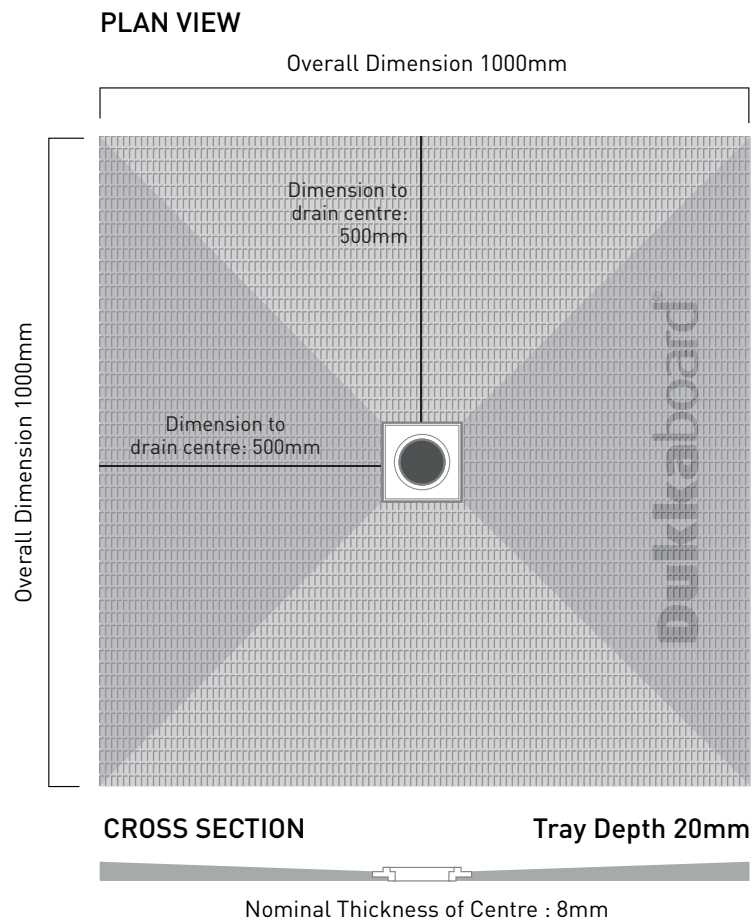

### Dukkaboard

Tel: 0870 1271 300  
Email: [info@dukkaboard.com](mailto:info@dukkaboard.com)



For technical information, support and more installation guides and videos from the expert team at Dukkaboard, visit [www.dukkaboard.com/the-knowledge-network](http://www.dukkaboard.com/the-knowledge-network)

[www.dukkaboard.com](http://www.dukkaboard.com)



## DUKKABOARD SHOWER TRAYS

Document number DTD-1008	Revision 1.1
Standard Dukkaboard Tray 1200 X 1200 X 20mm O/S	Product Code DS-SC-1212
To Suit Drain To suit DS-ST-0010 / DS-ST-0025	Date 07/09/2016

### PLAN VIEW

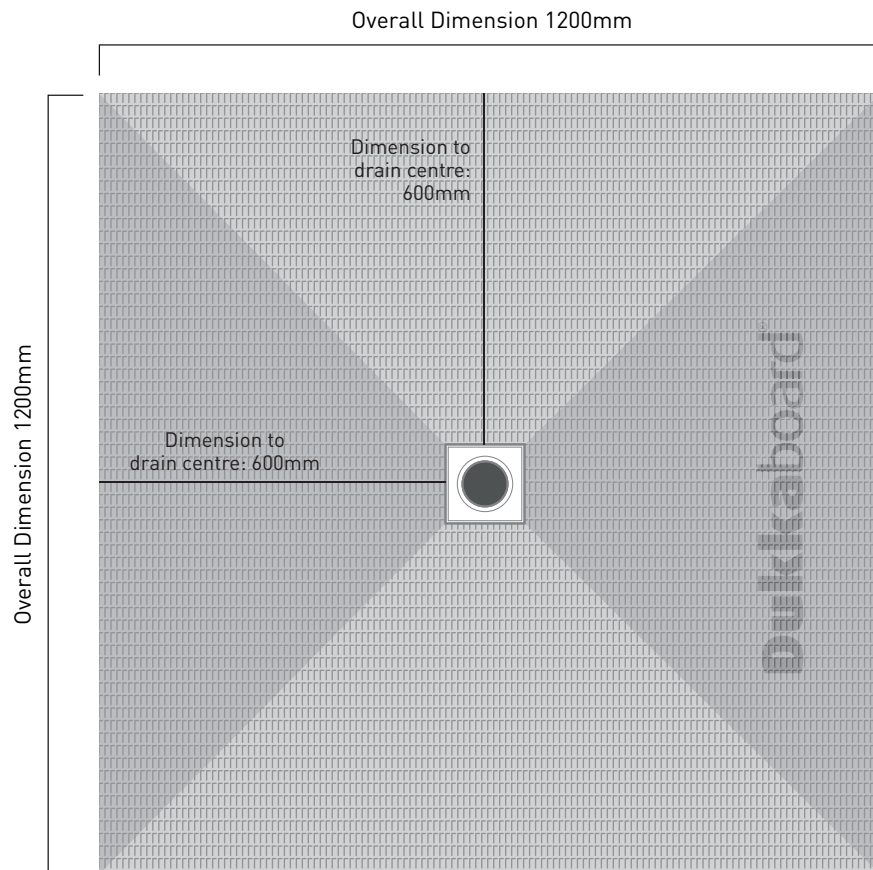

### CROSS SECTION

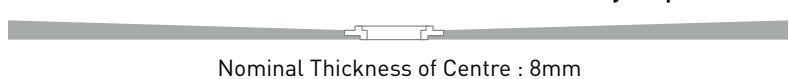

### Dukkaboard

Tel: 0870 1271 300  
Email: [info@dukkaboard.com](mailto:info@dukkaboard.com)



For technical information, support and more installation guides and videos from the expert team at Dukkaboard, visit [www.dukkaboard.com/the-knowledge-network](http://www.dukkaboard.com/the-knowledge-network)

[www.dukkaboard.com](http://www.dukkaboard.com)

## DUKKABOARD SHOWER TRAYS

Document number DTD-1009	Revision 1.1
Standard Dukkaboard Tray 1500 X 1500 X 20mm O/S	Product Code DS-SC-1515
To Suit Drain To suit DS-ST-0010 / DS-ST-0025	Date 07/09/2016

### PLAN VIEW

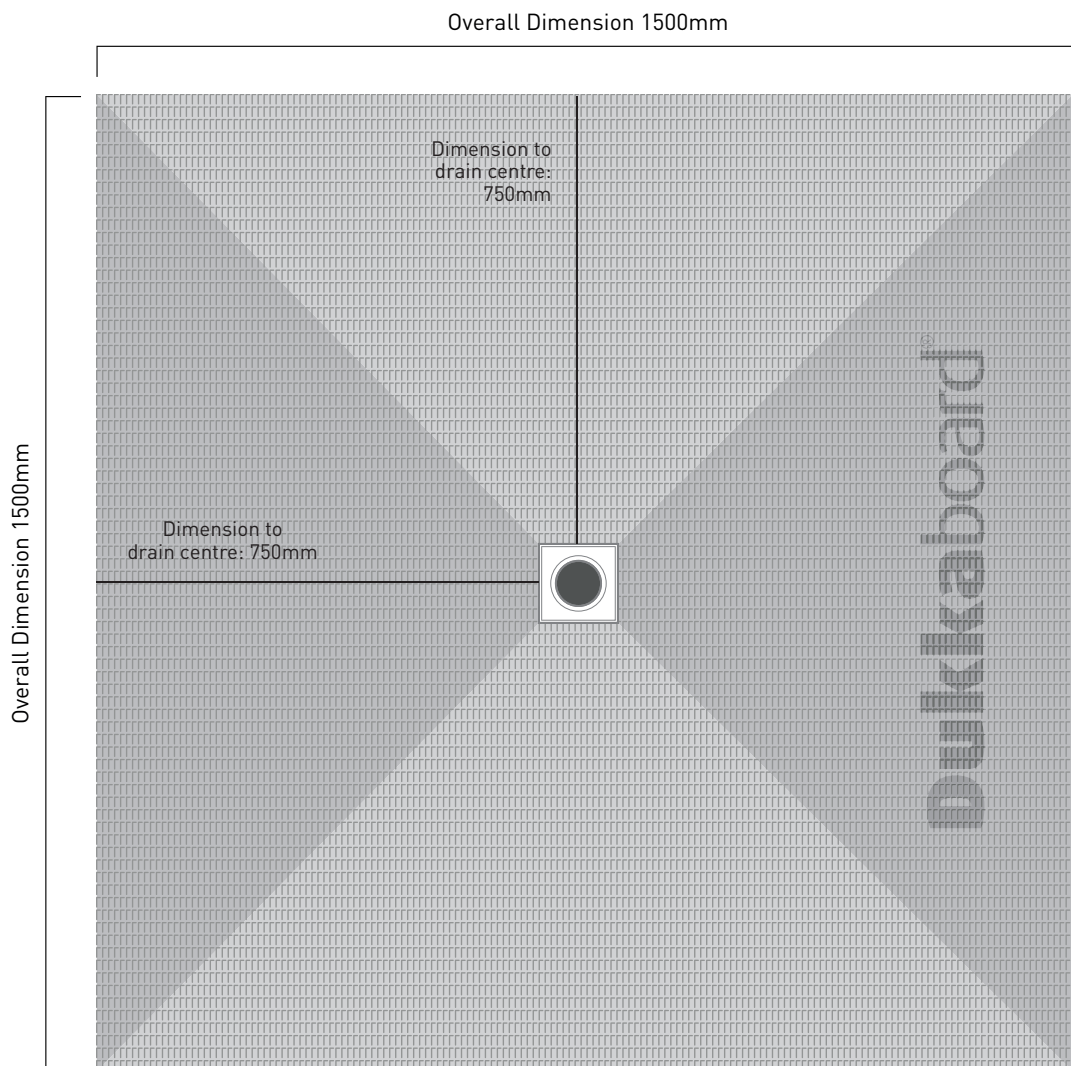

### CROSS SECTION

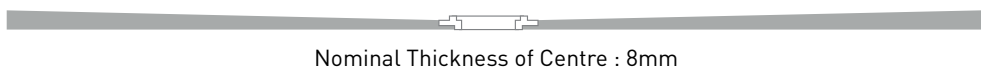

### Dukkaboard

Tel: 0870 1271 300  
Email: [info@dukkaboard.com](mailto:info@dukkaboard.com)



For technical information, support and more installation guides and videos from the expert team at Dukkaboard, visit [www.dukkaboard.com/the-knowledge-network](http://www.dukkaboard.com/the-knowledge-network)

[www.dukkaboard.com](http://www.dukkaboard.com)

## DUKKABOARD SHOWER TRAYS

Document number DTD-1010	Revision 1.1
Standard Dukkaboard Tray 1100 X 800 X 20mm O/S	Product Code DS-RE-1180
To Suit Drain To suit DS-ST-0010 / DS-ST-0025	Date 07/09/2016

### PLAN VIEW

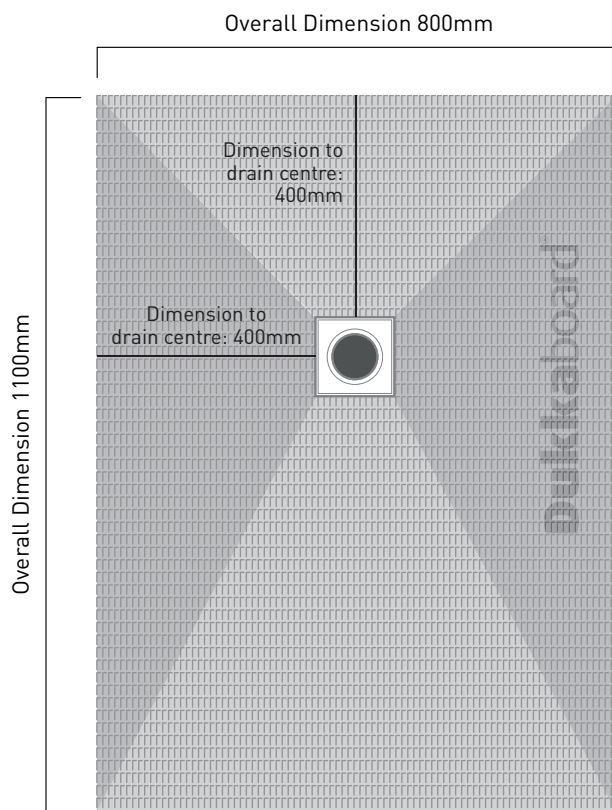

### CROSS SECTION

Tray Depth 20mm

Nominal Thickness of Centre : 8mm

### Dukkaboard

Tel: 0870 1271 300  
 Email: [info@dukkaboard.com](mailto:info@dukkaboard.com)



For technical information, support and more installation guides and videos from the expert team at Dukkaboard, visit [www.dukkaboard.com/the-knowledge-network](http://www.dukkaboard.com/the-knowledge-network)

[www.dukkaboard.com](http://www.dukkaboard.com)

## DUKKABOARD SHOWER TRAYS

Document number DTD-1011	Revision 1.1
Standard Dukkaboard Tray 1200 X 800 X 20mm O/S	Product Code DS-RE-1280
To Suit Drain To suit DS-ST-0010 / DS-ST-0025	Date 07/09/2016

### PLAN VIEW

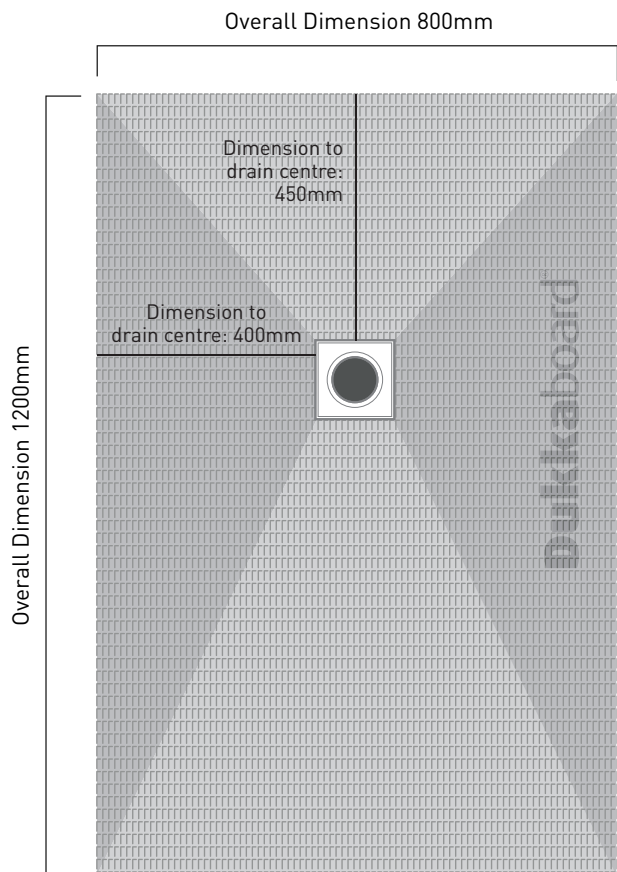

### CROSS SECTION

Tray Depth 20mm

Nominal Thickness of Centre : 8mm

## DUKKABOARD SHOWER TRAYS

Document number DTD-1012	Revision 1.1
Standard Dukkaboard Tray 1200 X 900 X 20mm O/S	Product Code DS-RE-1290
To Suit Drain To suit DS-ST-0010 / DS-ST-0025	Date 07/09/2016

### PLAN VIEW

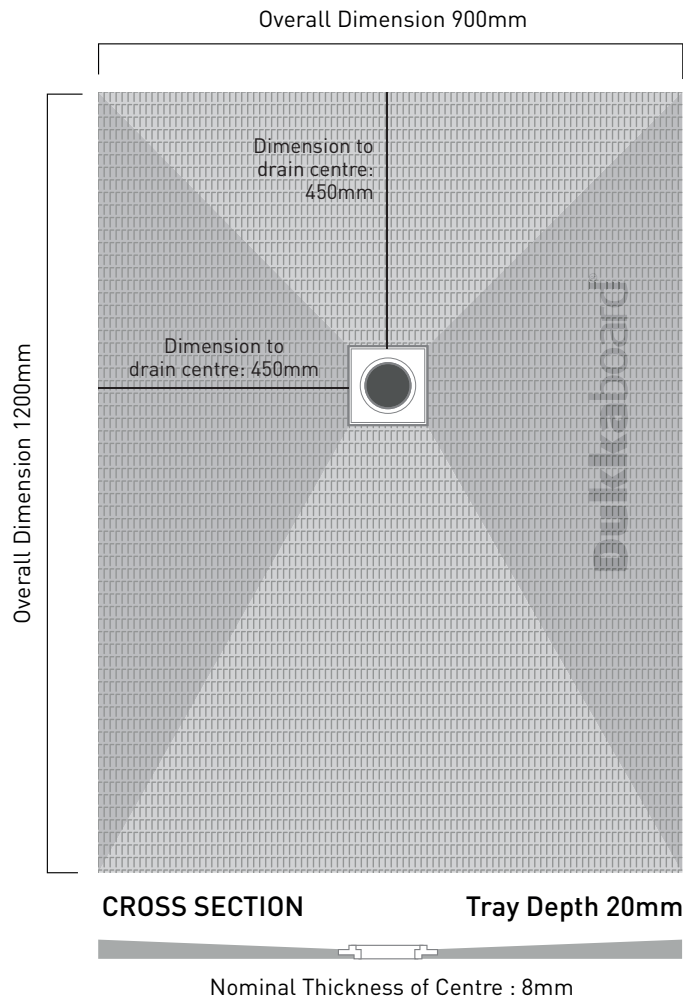

## DUKKABOARD SHOWER TRAYS

Document number DTD-1013	Revision 1.1
Standard Dukkaboard Tray 1200 X 1000 X 20mm O/S	Product Code DS-RE-1210
To Suit Drain To suit DS-ST-0010 / DS-ST-0025	Date 07/09/2016

### PLAN VIEW

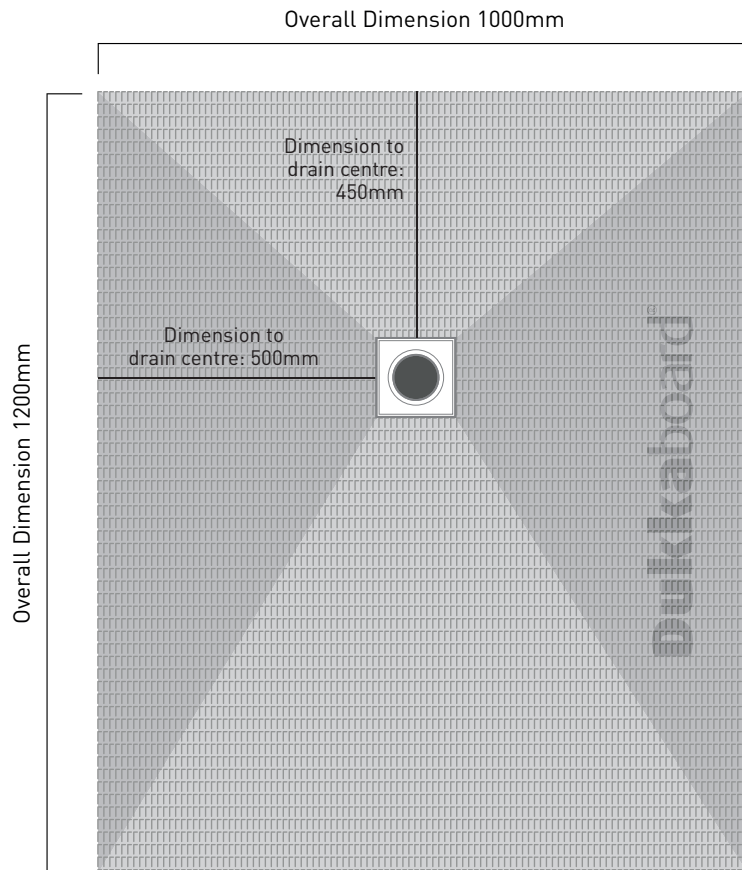

### CROSS SECTION



Tray Depth 20mm

Nominal Thickness of Centre : 8mm

### Dukkaboard

Tel: 0870 1271 300  
Email: [info@dukkaboard.com](mailto:info@dukkaboard.com)



For technical information, support and more installation guides and videos from the expert team at Dukkaboard, visit [www.dukkaboard.com/the-knowledge-network](http://www.dukkaboard.com/the-knowledge-network)

[www.dukkaboard.com](http://www.dukkaboard.com)

## DUKKABOARD SHOWER TRAYS

Document number DTD-1014	Revision 1.1
Standard Dukkaboard Tray 1400 X 760 X 25mm O/S	Product Code DS-RE-1476
To Suit Drain To suit DS-ST-0010 / DS-ST-0025	Date 07/09/2016

### PLAN VIEW

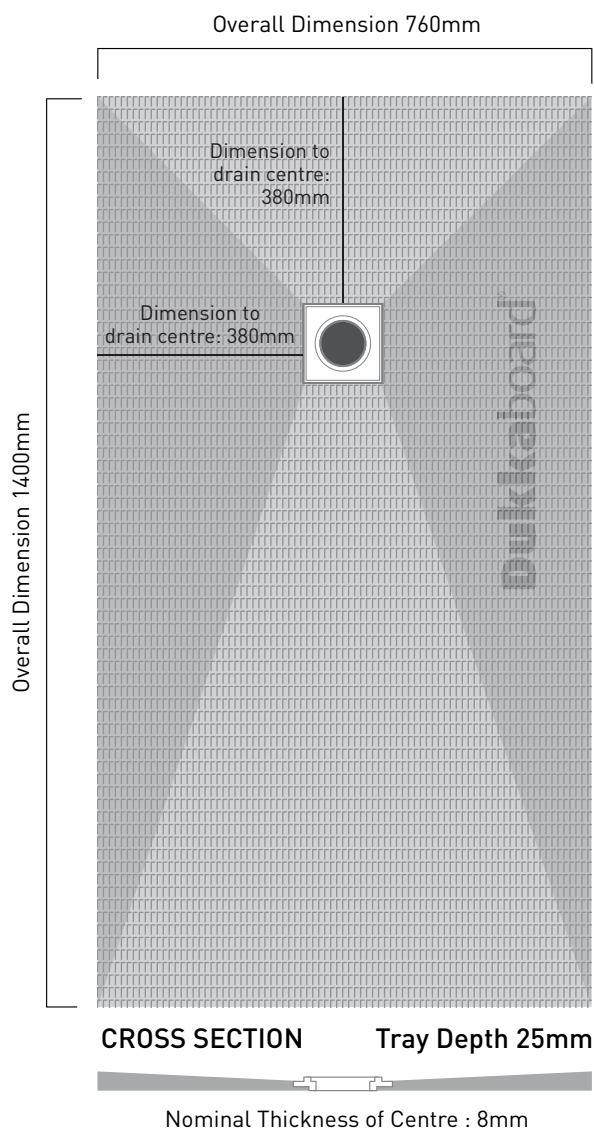

### Dukkaboard

Tel: 0870 1271 300  
Email: [info@dukkaboard.com](mailto:info@dukkaboard.com)



For technical information, support and more installation guides and videos from the expert team at Dukkaboard, visit [www.dukkaboard.com/the-knowledge-network](http://www.dukkaboard.com/the-knowledge-network)

[www.dukkaboard.com](http://www.dukkaboard.com)

## DUKKABOARD SHOWER TRAYS

Document number DTD-1015	Revision 1.1
Standard Dukkaboard Tray 1400 X 900 X 25mm O/S	Product Code DS-RE-1490
To Suit Drain To suit DS-ST-0010 / DS-ST-0025	Date 07/09/2016

### PLAN VIEW

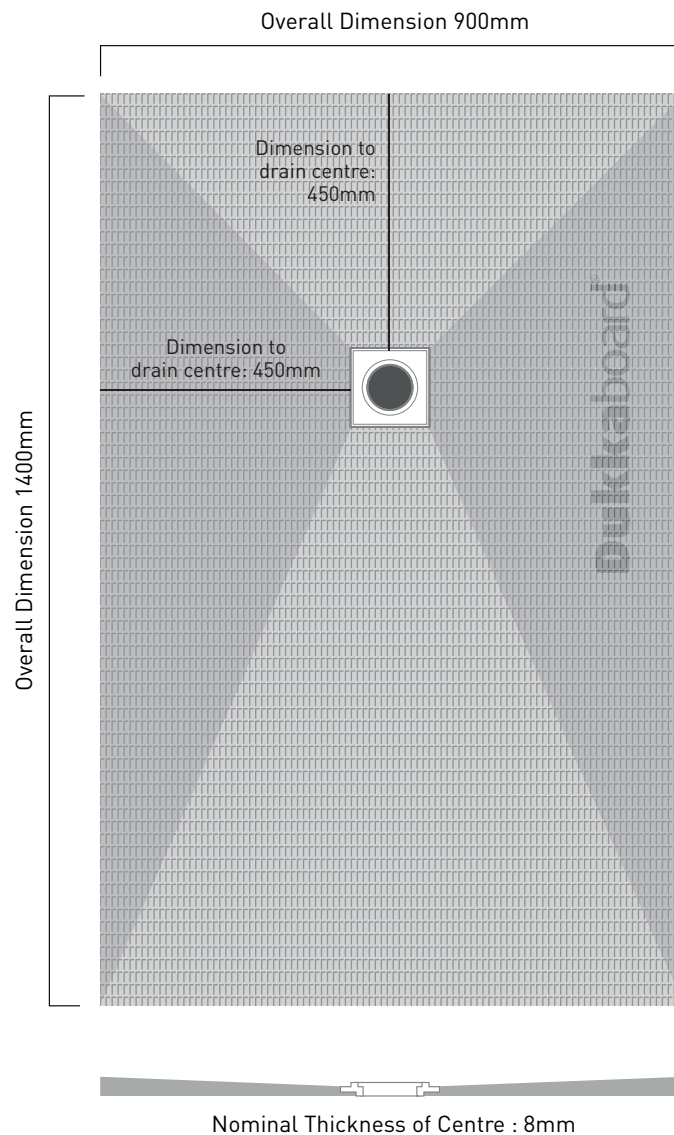

### Dukkaboard

Tel: 0870 1271 300  
 Email: [info@dukkaboard.com](mailto:info@dukkaboard.com)



For technical information, support and more installation guides and videos from the expert team at Dukkaboard, visit [www.dukkaboard.com/the-knowledge-network](http://www.dukkaboard.com/the-knowledge-network)

[www.dukkaboard.com](http://www.dukkaboard.com)



## DUKKABOARD SHOWER TRAYS

Document number DTD-1016	Revision 1.1
Standard Dukkaboard Tray 1500 X 800 X 25mm O/S	Product Code DS-RE-1580
To Suit Drain To suit DS-ST-0010 / DS-ST-0025	Date 07/09/2016

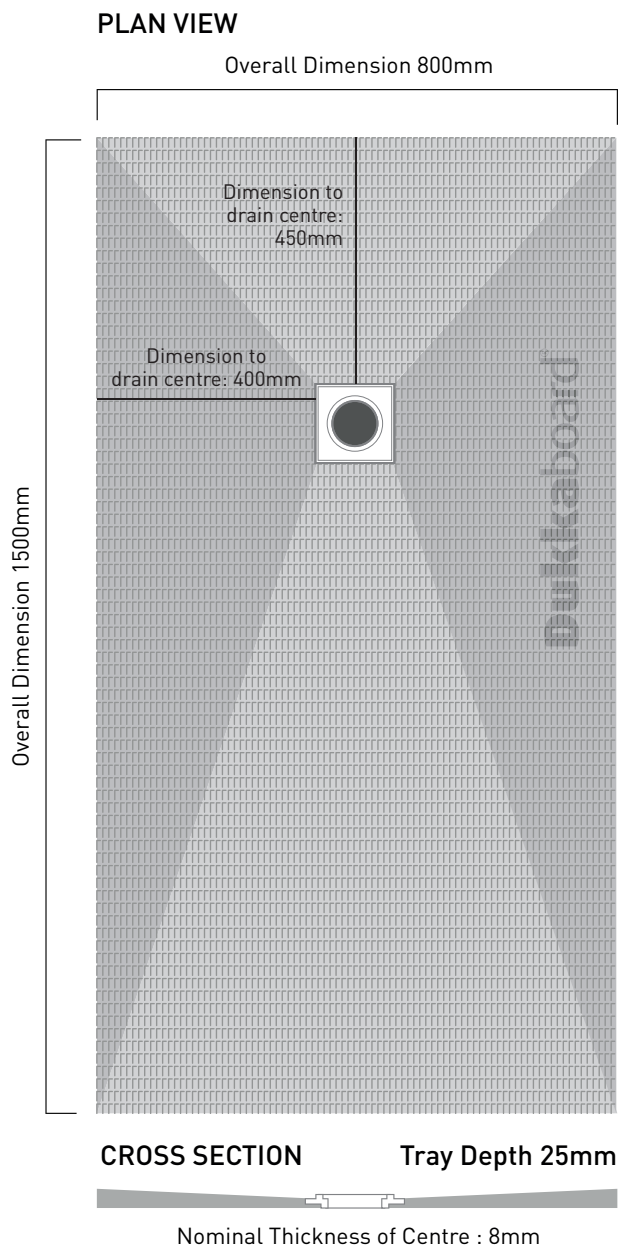

## DUKKABOARD SHOWER TRAYS

Document number DTD-1017	Revision 1.1
Standard Dukkaboard Tray 1600 X 760 X 30mm O/S	Product Code DS-RE-1676
To Suit Drain To suit DS-ST-0010 / DS-ST-0025	Date 07/09/2016

### PLAN VIEW

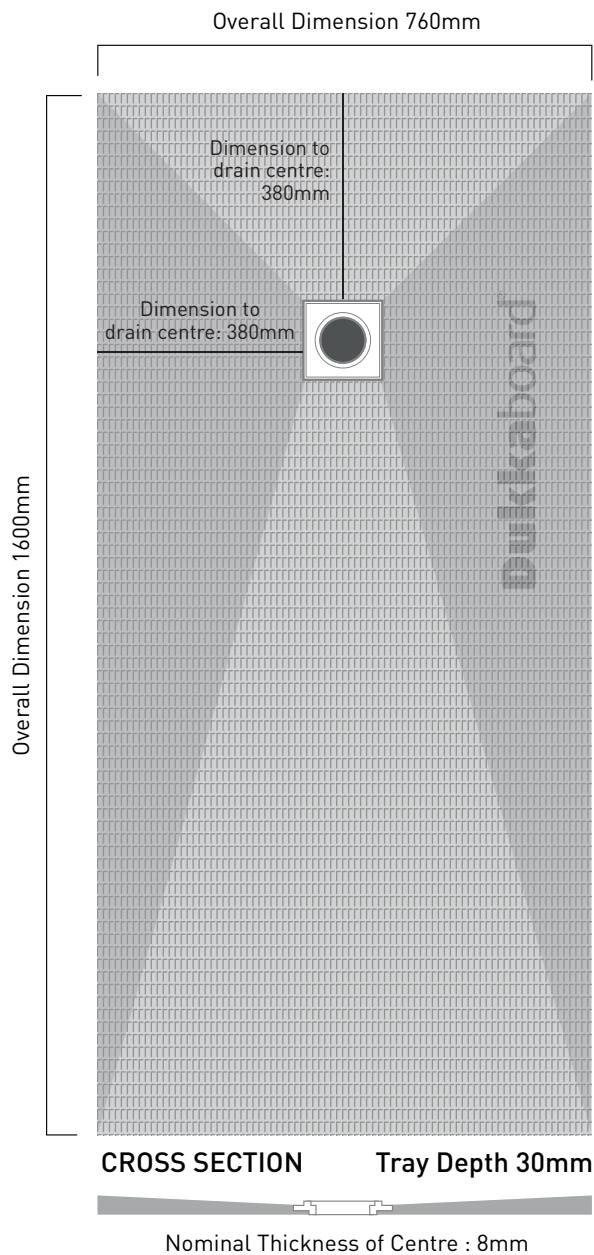

### Dukkaboard

Tel: 0870 1271 300  
Email: [info@dukkaboard.com](mailto:info@dukkaboard.com)



For technical information, support and more installation guides and videos from the expert team at Dukkaboard, visit [www.dukkaboard.com/the-knowledge-network](http://www.dukkaboard.com/the-knowledge-network)

[www.dukkaboard.com](http://www.dukkaboard.com)

## DUKKABOARD SHOWER TRAYS

Document number DTD-1018	Revision 1.1
Standard Dukkaboard Tray 1600 X 900 X 30mm O/S	Product Code DS-RE-1690
To Suit Drain To suit DS-ST-0010 / DS-ST-0025	Date 07/09/2016

### PLAN VIEW

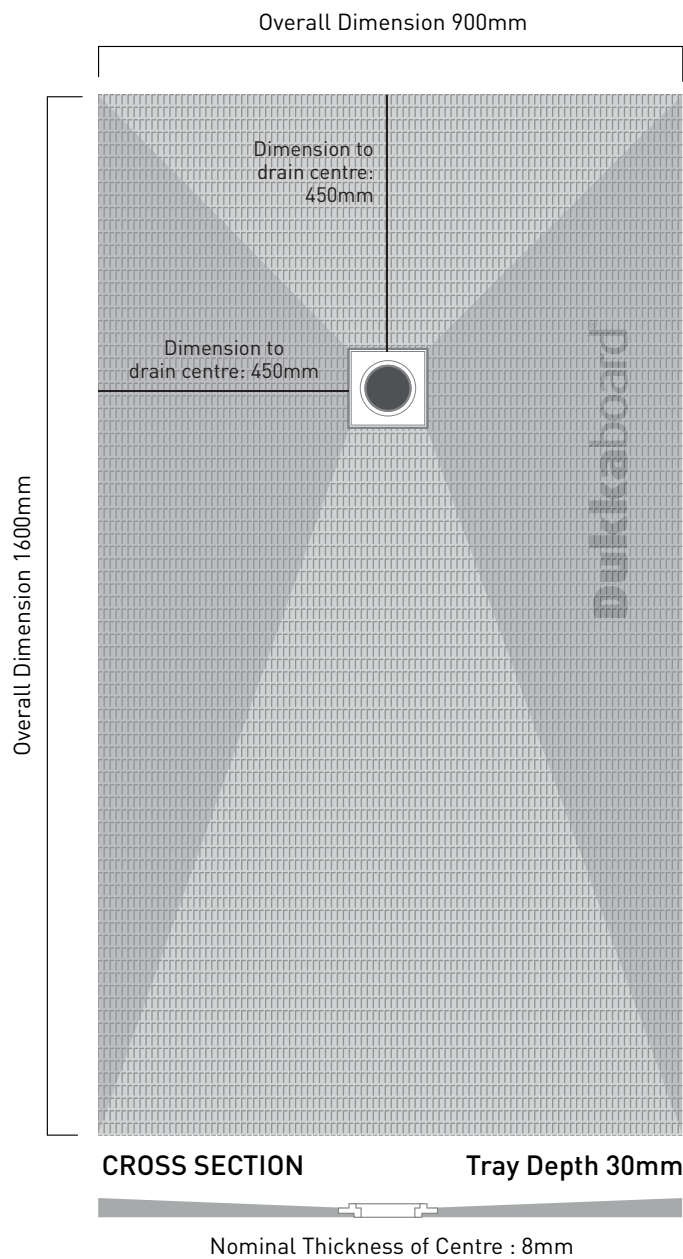

### Dukkaboard

Tel: 0870 1271 300  
Email: [info@dukkaboard.com](mailto:info@dukkaboard.com)



For technical information, support and more installation guides and videos from the expert team at Dukkaboard, visit [www.dukkaboard.com/the-knowledge-network](http://www.dukkaboard.com/the-knowledge-network)

[www.dukkaboard.com](http://www.dukkaboard.com)

## DUKKABOARD SHOWER TRAYS

Document number DTD-1019	Revision 1.1
Standard Dukkaboard Tray 1700 X 760 X 30mm O/S	Product Code DS-RE-1776
To Suit Drain To suit DS-ST-0010 / DS-ST-0025	Date 07/09/2016

### PLAN VIEW

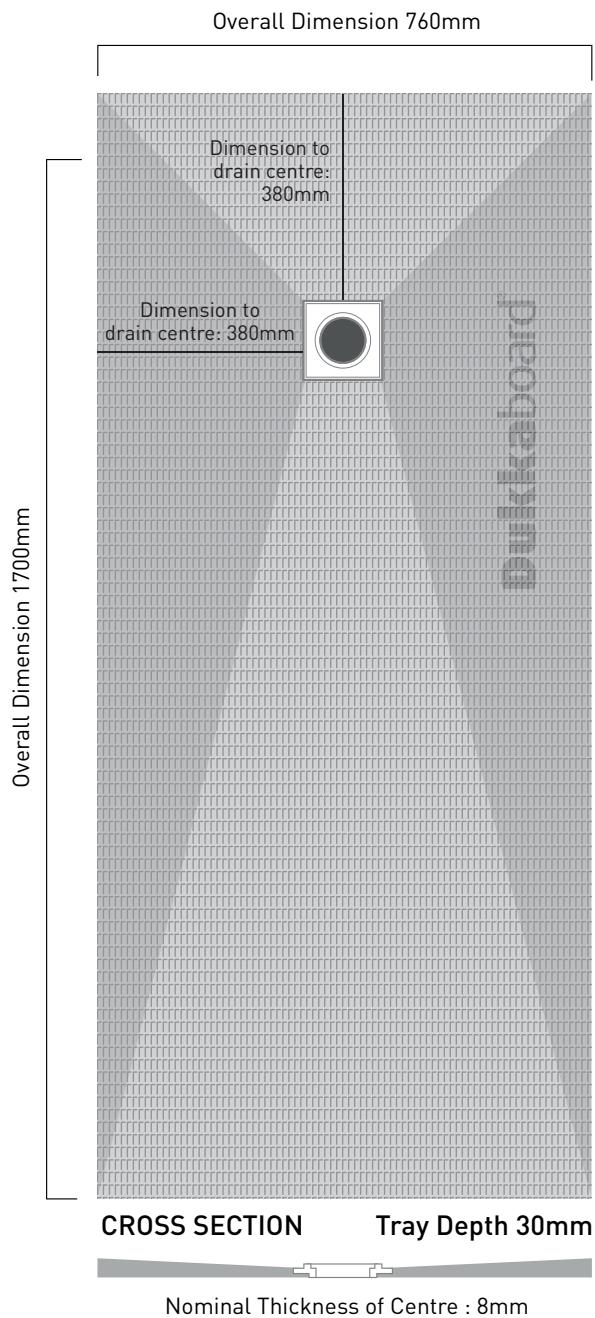

### Dukkaboard

Tel: 0870 1271 300  
Email: [info@dukkaboard.com](mailto:info@dukkaboard.com)



For technical information, support and more installation guides and videos from the expert team at Dukkaboard, visit [www.dukkaboard.com/the-knowledge-network](http://www.dukkaboard.com/the-knowledge-network)

[www.dukkaboard.com](http://www.dukkaboard.com)

## DUKKABOARD SHOWER TRAYS

Document number DTD-1020	Revision 1.1
Standard Dukkaboard Tray 1700 X 800 X 30mm O/S	Product Code DS-RE-1780
To Suit Drain To suit DS-ST-0010 / DS-ST-0025	Date 07/09/2016

### PLAN VIEW

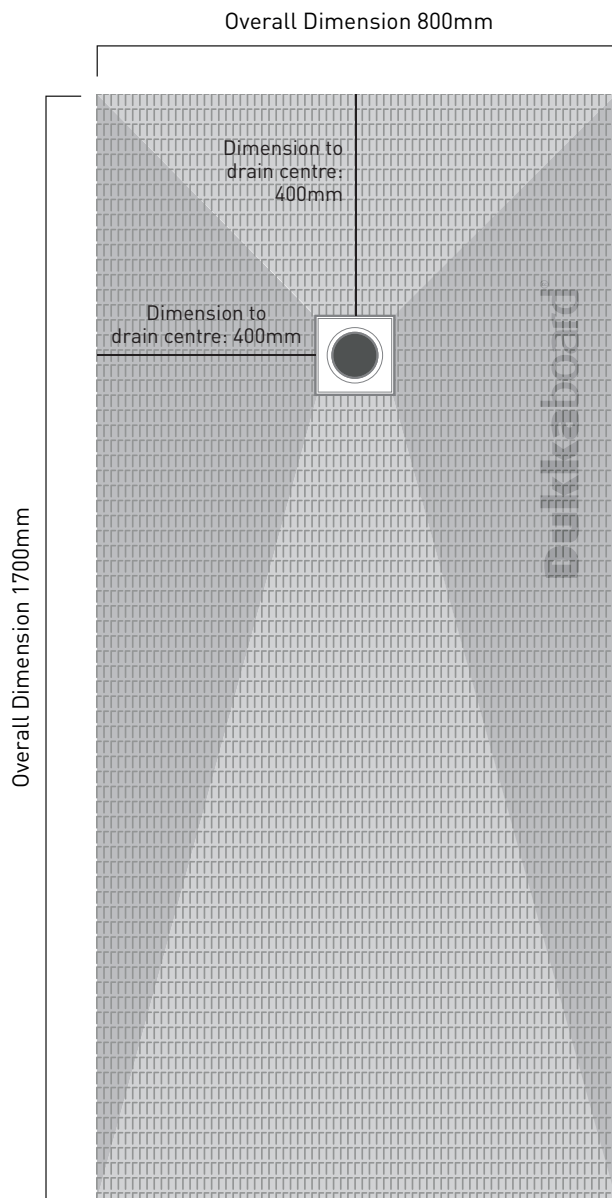

### CROSS SECTION

Tray Depth 30mm

Nominal Thickness of Centre : 8mm

### Dukkaboard

Tel: 0870 1271 300  
Email: [info@dukkaboard.com](mailto:info@dukkaboard.com)



For technical information, support and more installation guides and videos from the expert team at Dukkaboard, visit [www.dukkaboard.com/the-knowledge-network](http://www.dukkaboard.com/the-knowledge-network)

[www.dukkaboard.com](http://www.dukkaboard.com)

## DUKKABOARD SHOWER TRAYS

Document number DTD-1021	Revision 1.1
Standard Dukkaboard Tray 1700 X 900 X 30mm O/S	Product Code DS-RE-1790
To Suit Drain To suit DS-ST-0010 / DS-ST-0025	Date 07/09/2016

### PLAN VIEW

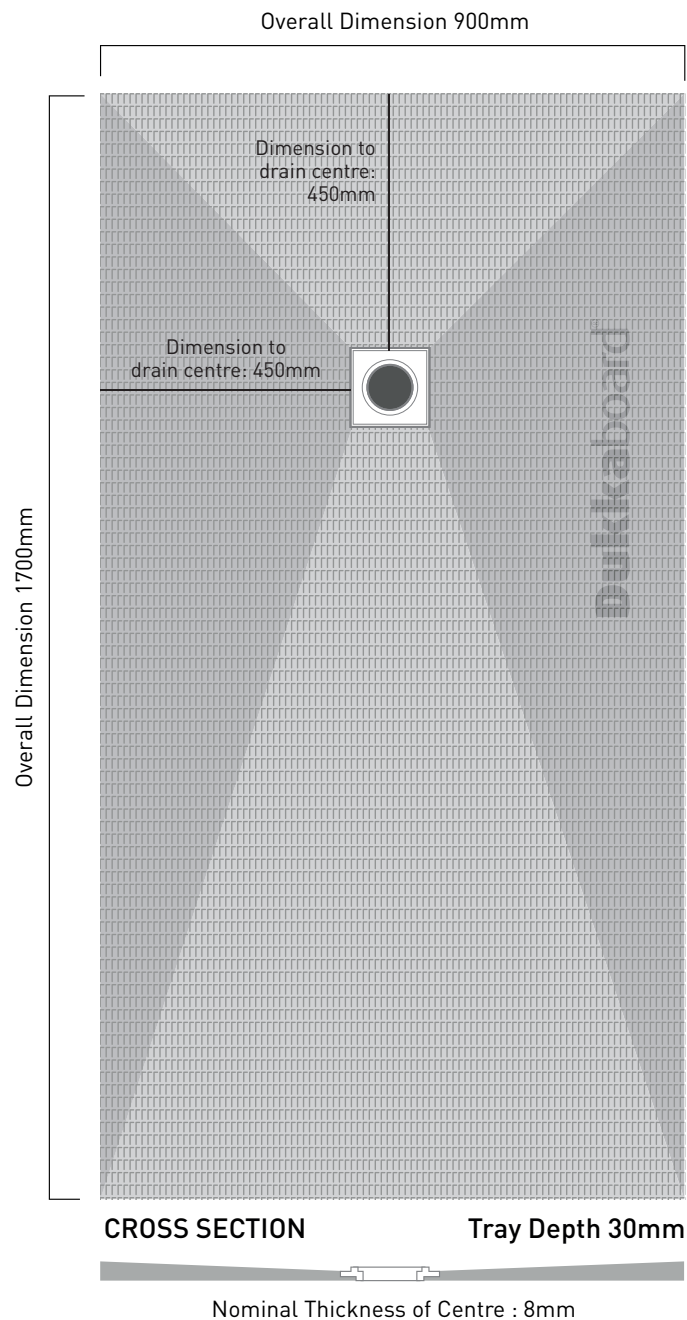

### Dukkaboard

Tel: 0870 1271 300  
Email: [info@dukkaboard.com](mailto:info@dukkaboard.com)



For technical information, support and more installation guides and videos from the expert team at Dukkaboard, visit [www.dukkaboard.com/the-knowledge-network](http://www.dukkaboard.com/the-knowledge-network)

[www.dukkaboard.com](http://www.dukkaboard.com)

## DUKKABOARD SHOWER TRAYS

Document number DTD-1022	Revision 1.1
Standard Dukkaboard Tray 1800 X 800 X 25mm O/S	Product Code DS-RE-1880
To Suit Drain To suit DS-ST-0010 / DS-ST-0025	Date 07/09/2016

### PLAN VIEW

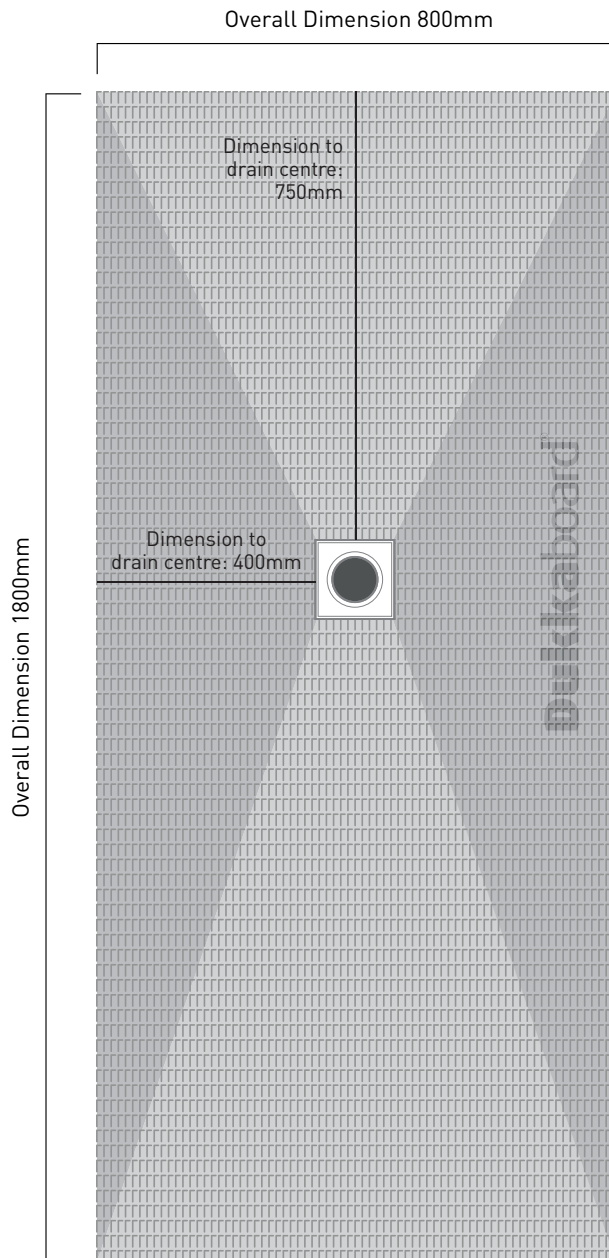

### CROSS SECTION

Tray Depth 25mm



Nominal Thickness of Centre : 8mm

### Dukkaboard

Tel: 0870 1271 300  
Email: [info@dukkaboard.com](mailto:info@dukkaboard.com)



For technical information, support and more installation guides and videos from the expert team at Dukkaboard, visit [www.dukkaboard.com/the-knowledge-network](http://www.dukkaboard.com/the-knowledge-network)

[www.dukkaboard.com](http://www.dukkaboard.com)

## DUKKABOARD SHOWER TRAYS

Document number DTD-1023	Revision 1.1
Standard Dukkaboard Tray 1800 X 900 X 30mm O/S	Product Code DS-RE-1890
To Suit Drain To suit DS-ST-0010 / DS-ST-0025	Date 07/09/2016

### PLAN VIEW

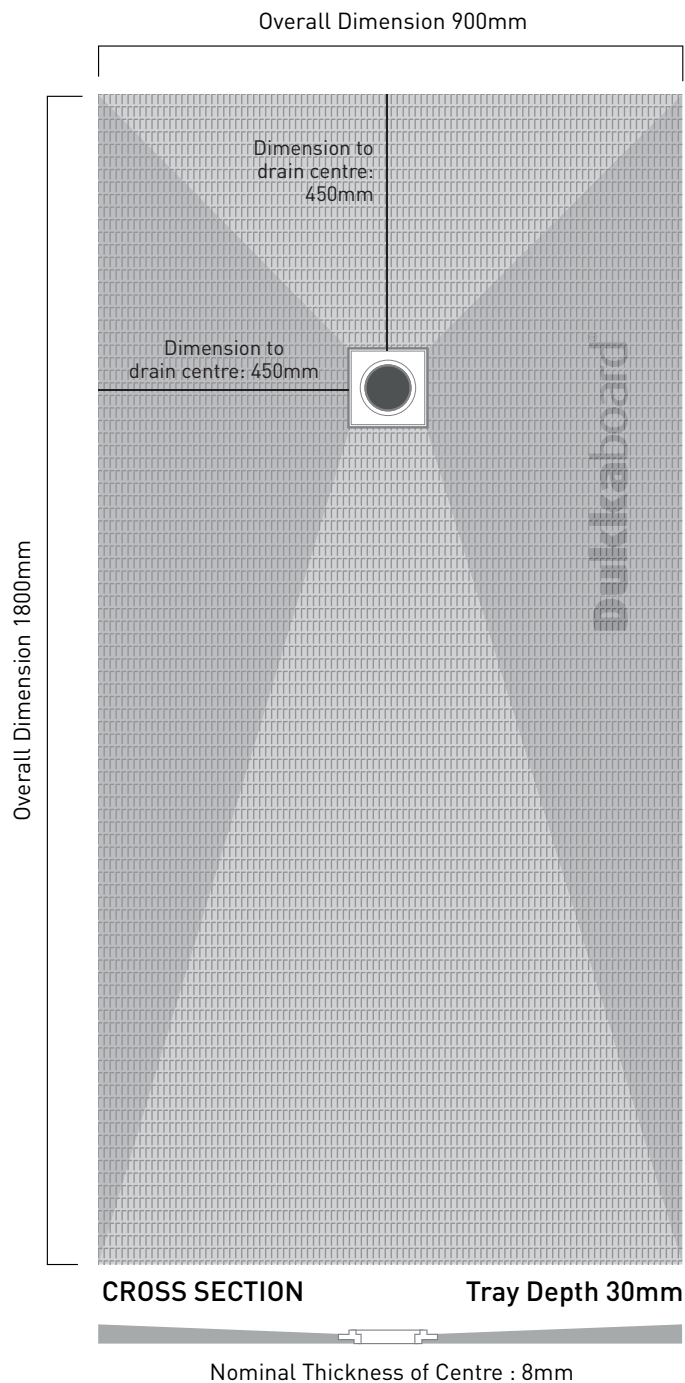

### Dukkaboard

Tel: 0870 1271 300  
Email: [info@dukkaboard.com](mailto:info@dukkaboard.com)



For technical information, support and more installation guides and videos from the expert team at Dukkaboard, visit [www.dukkaboard.com/the-knowledge-network](http://www.dukkaboard.com/the-knowledge-network)

[www.dukkaboard.com](http://www.dukkaboard.com)



## DUKKABOARD SHOWER TRAYS

Document number DTD-1024	Revision 1.1
Standard Dukkaboard Tray 1200 X 900 X 20mm O/S	Product Code DS-RR-0010
To Suit Drain To suit DS-ST-0010 / DS-ST-0025	Date 07/09/2016

### PLAN VIEW

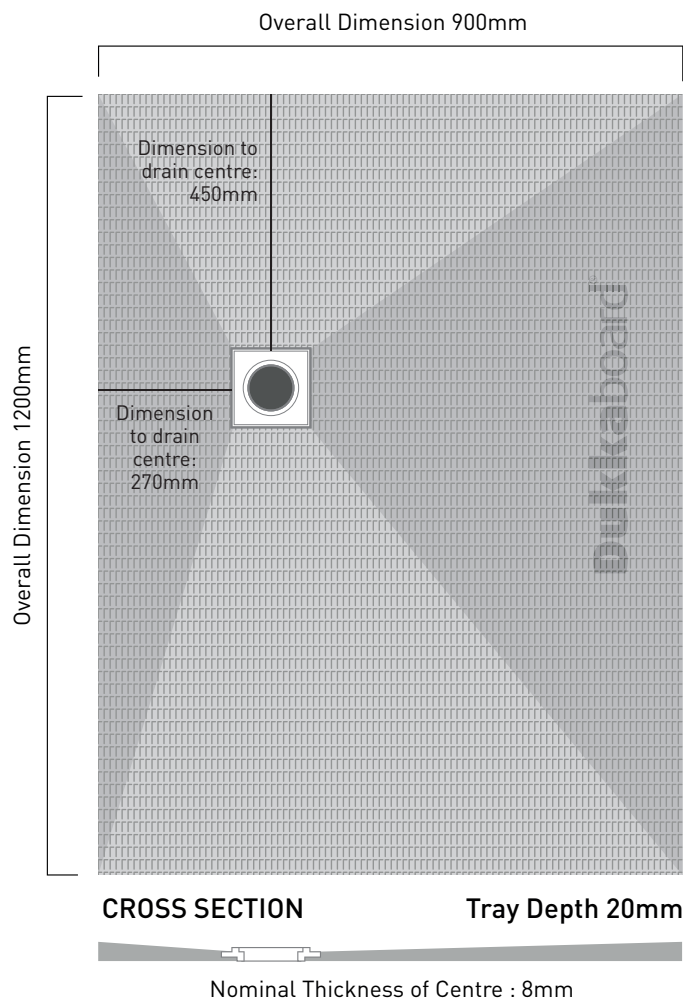

### Dukkaboard

Tel: 0870 1271 300  
Email: [info@dukkaboard.com](mailto:info@dukkaboard.com)



For technical information, support and more installation guides and videos from the expert team at Dukkaboard, visit [www.dukkaboard.com/the-knowledge-network](http://www.dukkaboard.com/the-knowledge-network)

[www.dukkaboard.com](http://www.dukkaboard.com)

## DUKKABOARD SHOWER TRAYS

Document number DTD-1025	Revision 1.1
Standard Dukkaboard Tray 1200 X 900 X 20mm O/S	Product Code DS-RR-0015
To Suit Drain To suit DS-ST-0010 / DS-ST-0025	Date 07/09/2016

### PLAN VIEW

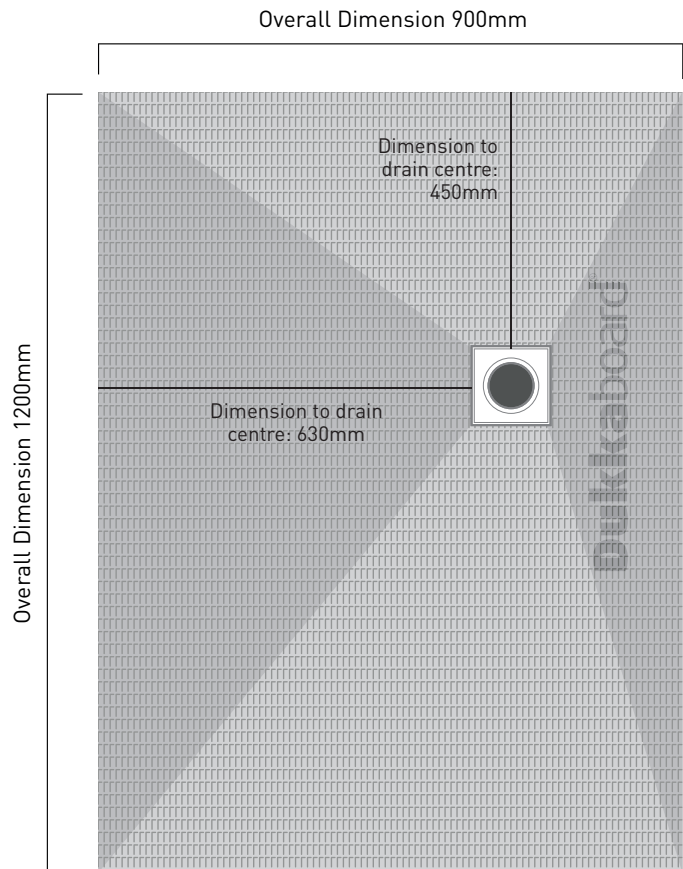

### CROSS SECTION

Tray Depth 20mm

Nominal Thickness of Centre : 8mm

### Dukkaboard

Tel: 0870 1271 300  
Email: [info@dukkaboard.com](mailto:info@dukkaboard.com)



For technical information, support and more installation guides and videos from the expert team at Dukkaboard, visit [www.dukkaboard.com/the-knowledge-network](http://www.dukkaboard.com/the-knowledge-network)

[www.dukkaboard.com](http://www.dukkaboard.com)

## DUKKABOARD SHOWER TRAYS

Document number DTD-1026	Revision 1.1
Standard Dukkaboard Tray 1000 X 1000 X 20mm O/S	Product Code DS-SR-1010
To Suit Drain To suit DS-ST-0010 / DS-ST-0025	Date 07/09/2016

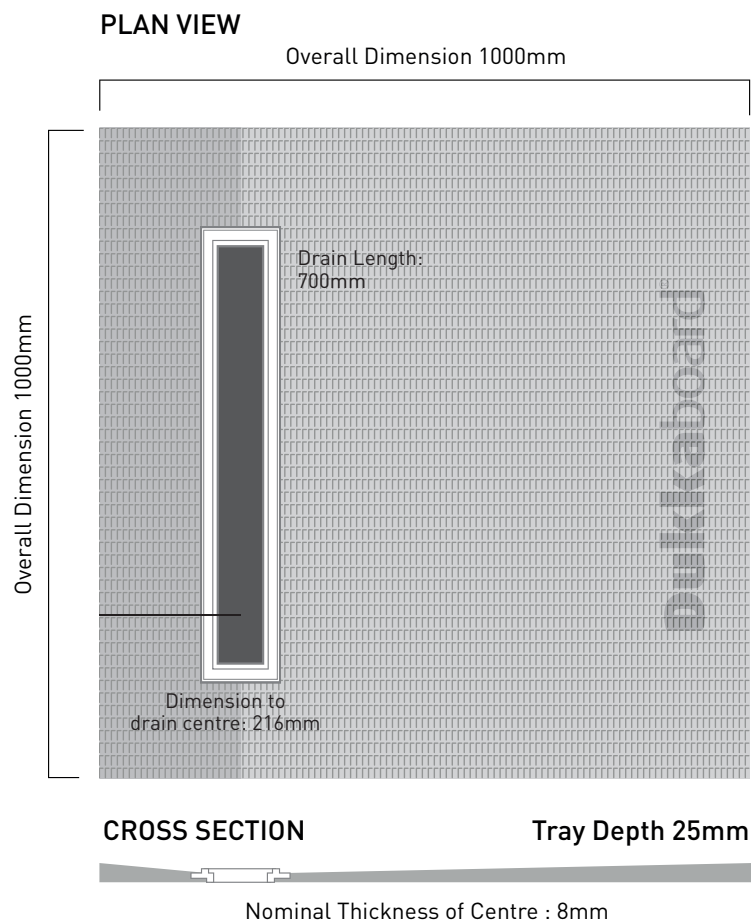

## DUKKABOARD SHOWER TRAYS

Document number DTD-1027	Revision 1.1
Standard Dukkaboard Tray 1200 X 1200 X 20mm O/S	Product Code DS-SE-1212
To Suit Drain To suit DS-ST-0010 / DS-ST-0025	Date 07/09/2016

### PLAN VIEW

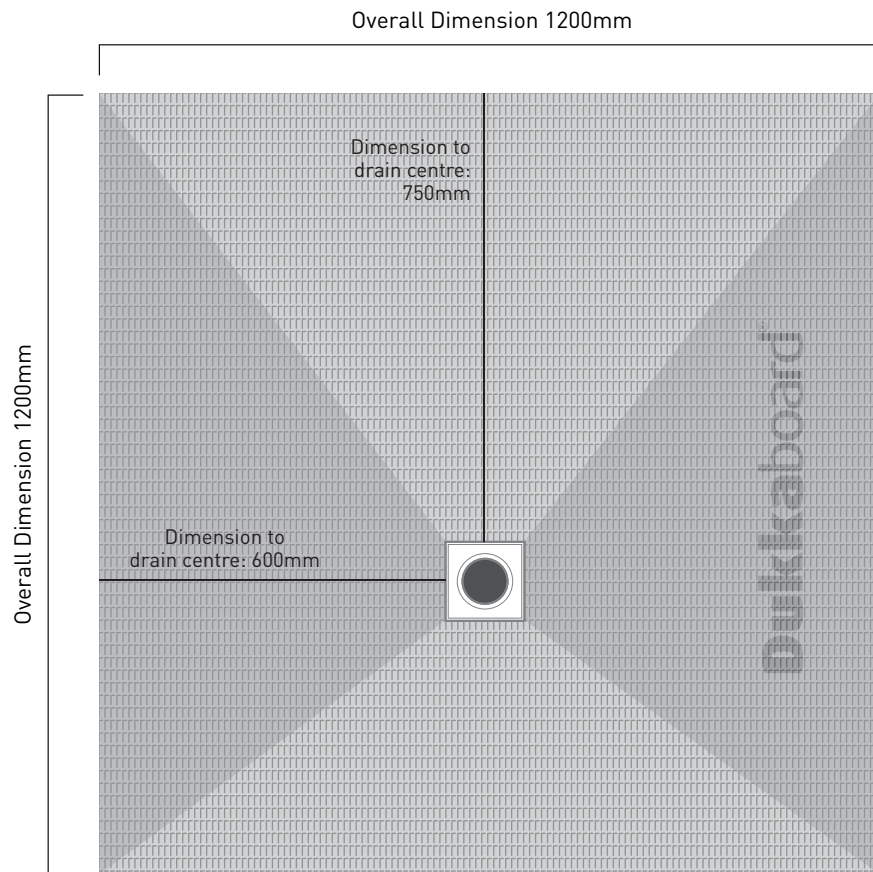

### CROSS SECTION

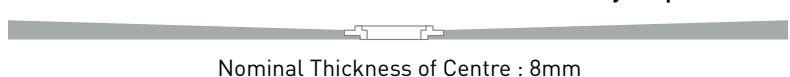

### Dukkaboard

Tel: 0870 1271 300  
Email: [info@dukkaboard.com](mailto:info@dukkaboard.com)



For technical information, support and more installation guides and videos from the expert team at Dukkaboard, visit [www.dukkaboard.com/the-knowledge-network](http://www.dukkaboard.com/the-knowledge-network)

[www.dukkaboard.com](http://www.dukkaboard.com)

## DUKKABOARD SHOWER TRAYS

Document number DTD-1028	Revision 1.1
Standard Dukkaboard Tray 800 X 1200 X 20mm O/S	Product Code DS-CD-8012
To Suit Drain Dukkaboard Channel E-Drain	Date 07/09/2016

### PLAN VIEW

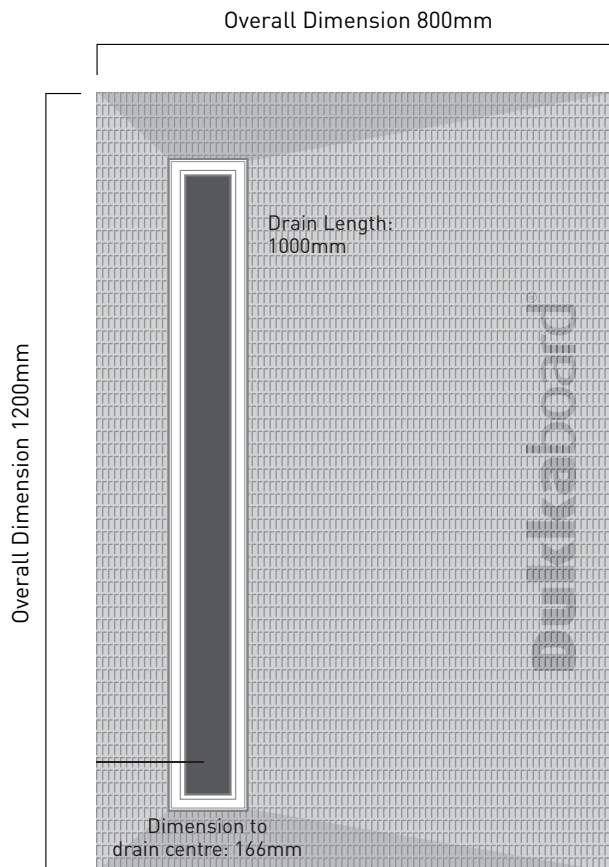

### CROSS SECTION

Tray Depth 20mm

Nominal Thickness of Centre : 8mm

### Dukkaboard

Tel: 0870 1271 300  
Email: [info@dukkaboard.com](mailto:info@dukkaboard.com)



For technical information, support and more installation guides and videos from the expert team at Dukkaboard, visit [www.dukkaboard.com/the-knowledge-network](http://www.dukkaboard.com/the-knowledge-network)

[www.dukkaboard.com](http://www.dukkaboard.com)

## DUKKABOARD SHOWER TRAYS

Document number DTD-1029	Revision 1.1
Standard Dukkaboard Tray 800 X 1500 X 20mm O/S	Product Code DS-CD-8015
To Suit Drain Dukkaboard Channel E-Drain	Date 07/09/2016

### PLAN VIEW

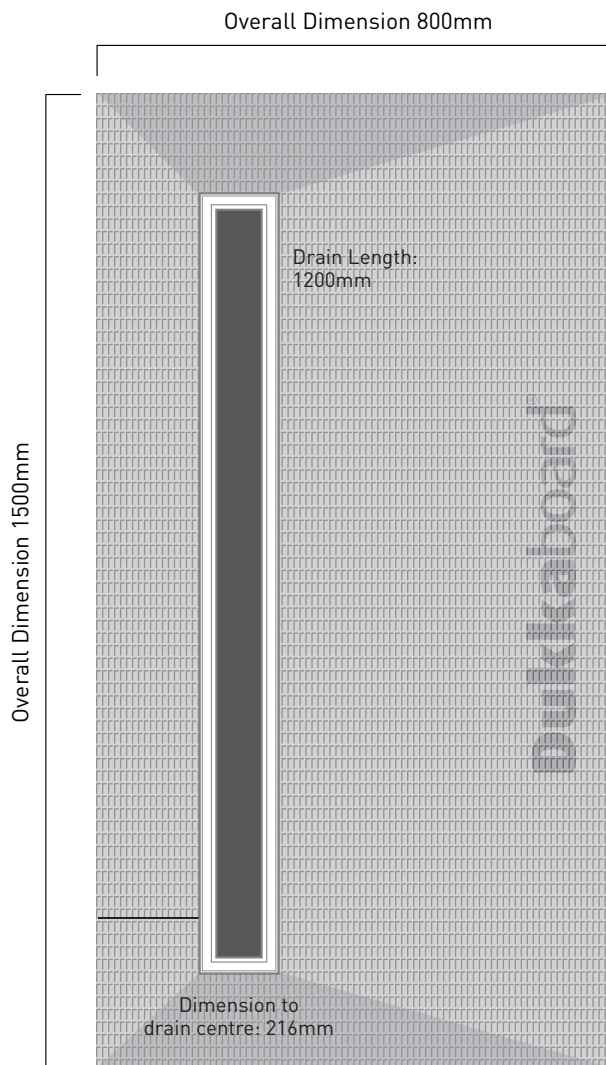

### CROSS SECTION

Tray Depth 20mm

Nominal Thickness of Centre : 8mm

### Dukkaboard

Tel: 0870 1271 300  
Email: [info@dukkaboard.com](mailto:info@dukkaboard.com)



For technical information, support and more installation guides and videos from the expert team at Dukkaboard, visit [www.dukkaboard.com/the-knowledge-network](http://www.dukkaboard.com/the-knowledge-network)

[www.dukkaboard.com](http://www.dukkaboard.com)

## DUKKABOARD SHOWER TRAYS

Document number DTD-1030	Revision 1.1
Standard Dukkaboard Tray 1000 X 1000 X 25mm O/S	Product Code DS-CD-1010
To Suit Drain Dukkaboard Channel E-Drain	Date 07/09/2016

### PLAN VIEW

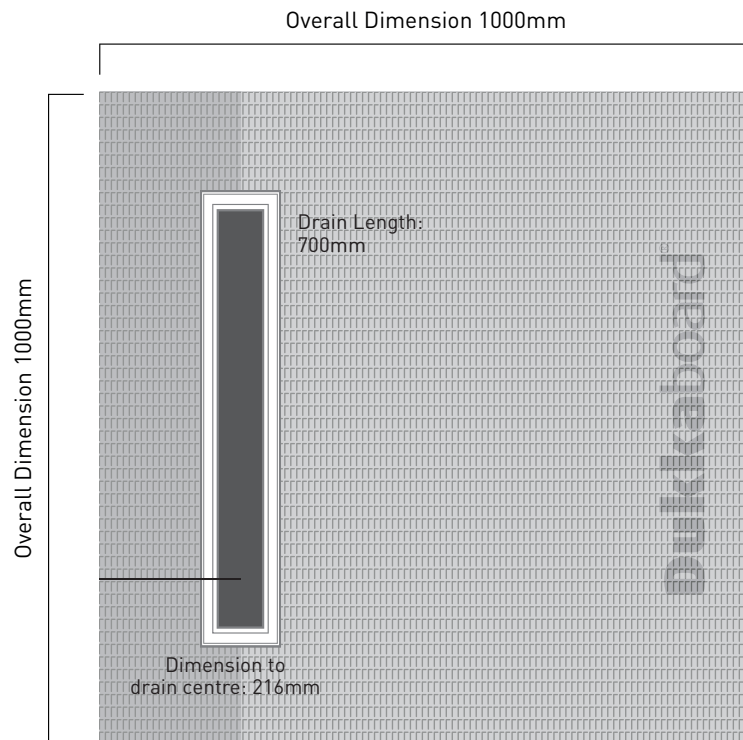

### CROSS SECTION

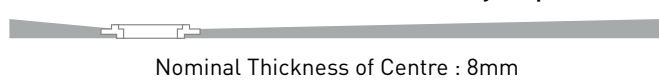

### Dukkaboard

Tel: 0870 1271 300  
Email: [info@dukkaboard.com](mailto:info@dukkaboard.com)



For technical information, support and more installation guides and videos from the expert team at Dukkaboard, visit [www.dukkaboard.com/the-knowledge-network](http://www.dukkaboard.com/the-knowledge-network)

[www.dukkaboard.com](http://www.dukkaboard.com)

## DUKKABOARD SHOWER TRAYS

Document number DTD-1031	Revision 1.1
Standard Dukkaboard Tray 1200 X 900 X 20mm O/S	Product Code DS-CD-1290
To Suit Drain Dukkaboard Channel E-Drain	Date 07/09/2016

### PLAN VIEW

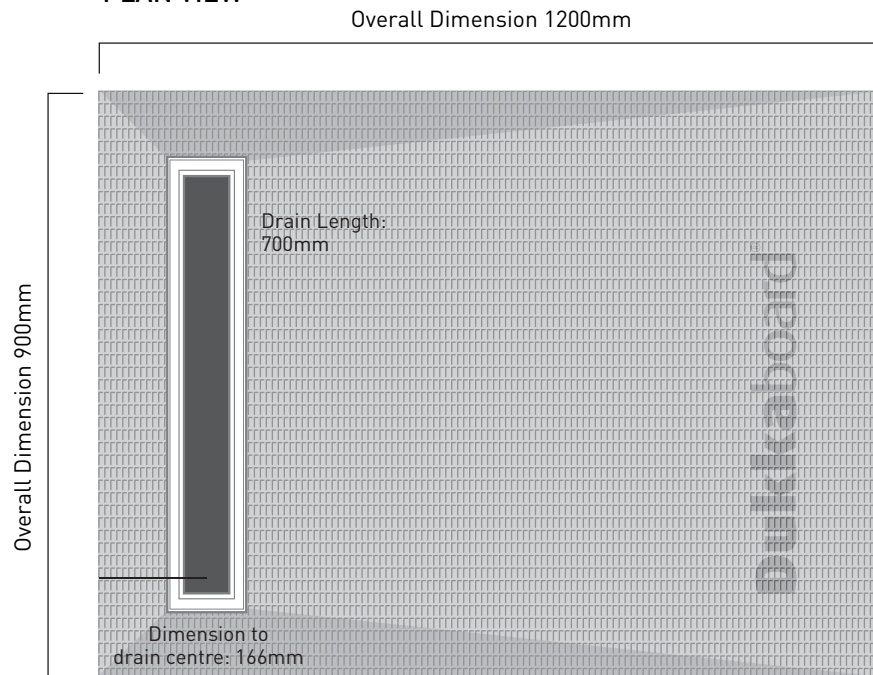

### CROSS SECTION



Tray Depth 20mm

Nominal Thickness of Centre : 8mm

### Dukkaboard

Tel: 0870 1271 300  
Email: [info@dukkaboard.com](mailto:info@dukkaboard.com)



For technical information, support and more installation guides and videos from the expert team at Dukkaboard, visit [www.dukkaboard.com/the-knowledge-network](http://www.dukkaboard.com/the-knowledge-network)

[www.dukkaboard.com](http://www.dukkaboard.com)



## DUKKABOARD SHOWER TRAYS

Document number DTD-1032	Revision 1.1
Standard Dukkaboard Tray 1200 X 1000 X 20mm O/S	Product Code DS-CD-1210
To Suit Drain Dukkaboard Channel E-Drain	Date 07/09/2016

### PLAN VIEW

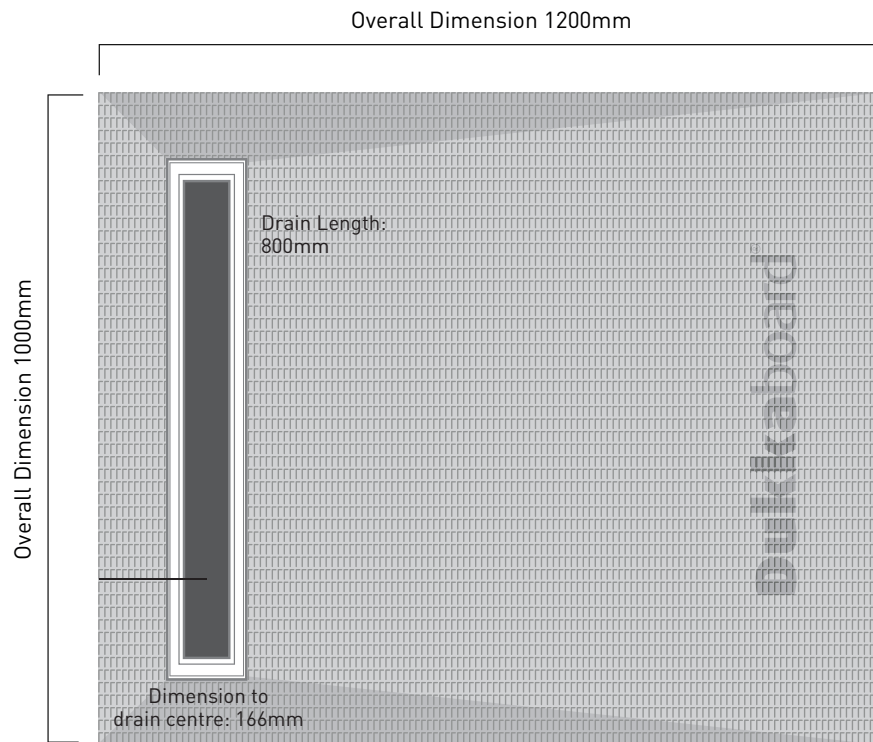

### CROSS SECTION

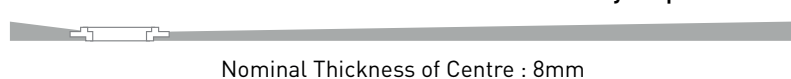

### Dukkaboard

Tel: 0870 1271 300  
 Email: [info@dukkaboard.com](mailto:info@dukkaboard.com)



For technical information, support and more installation guides and videos from the expert team at Dukkaboard, visit [www.dukkaboard.com/the-knowledge-network](http://www.dukkaboard.com/the-knowledge-network)

[www.dukkaboard.com](http://www.dukkaboard.com)

## DUKKABOARD SHOWER TRAYS

Document number DTD-1033	Revision 1.1
Standard Dukkaboard Tray 1200 X 1200 X 25mm O/S	Product Code DS-CD-1212
To Suit Drain Dukkaboard Channel E-Drain	Date 07/09/2016

### PLAN VIEW

Overall Dimension 1200mm

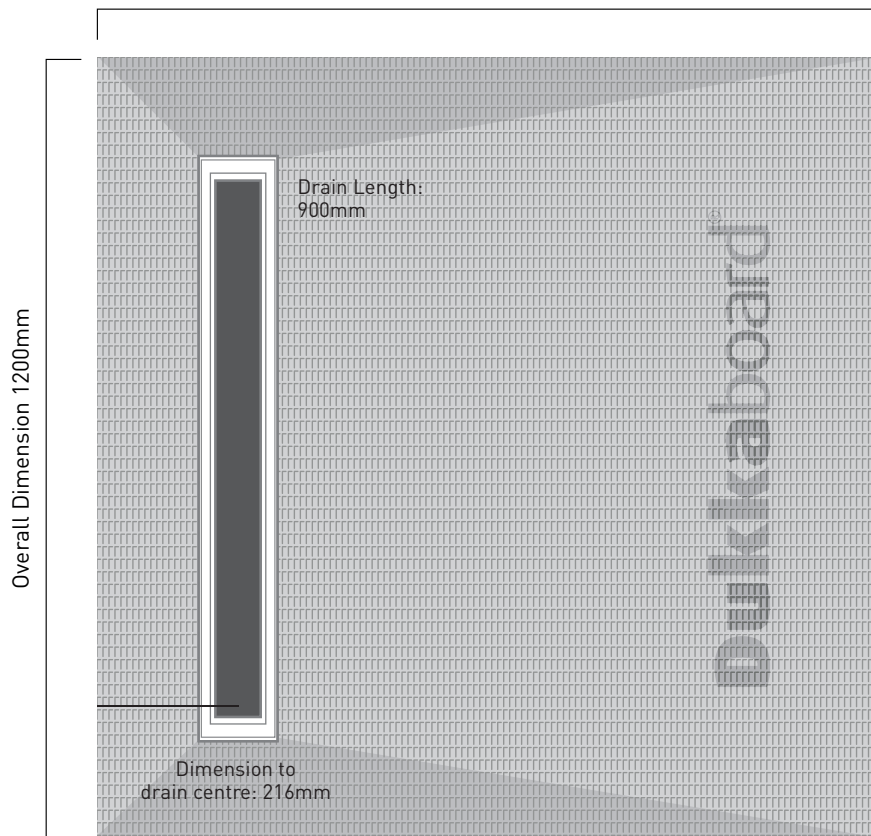

### CROSS SECTION

Tray Depth 25mm



Nominal Thickness of Centre : 8mm

### Dukkaboard

Tel: 0870 1271 300  
Email: [info@dukkaboard.com](mailto:info@dukkaboard.com)



For technical information, support and more installation guides and videos from the expert team at Dukkaboard, visit [www.dukkaboard.com/the-knowledge-network](http://www.dukkaboard.com/the-knowledge-network)

[www.dukkaboard.com](http://www.dukkaboard.com)

## DUKKABOARD SHOWER TRAYS

Document number DTD-1034	Revision 1.1
Standard Dukkaboard Tray 1400 X 800 X 25mm O/S	Product Code DS-CD-1480
To Suit Drain Dukkaboard Channel E-Drain	Date 07/09/2016

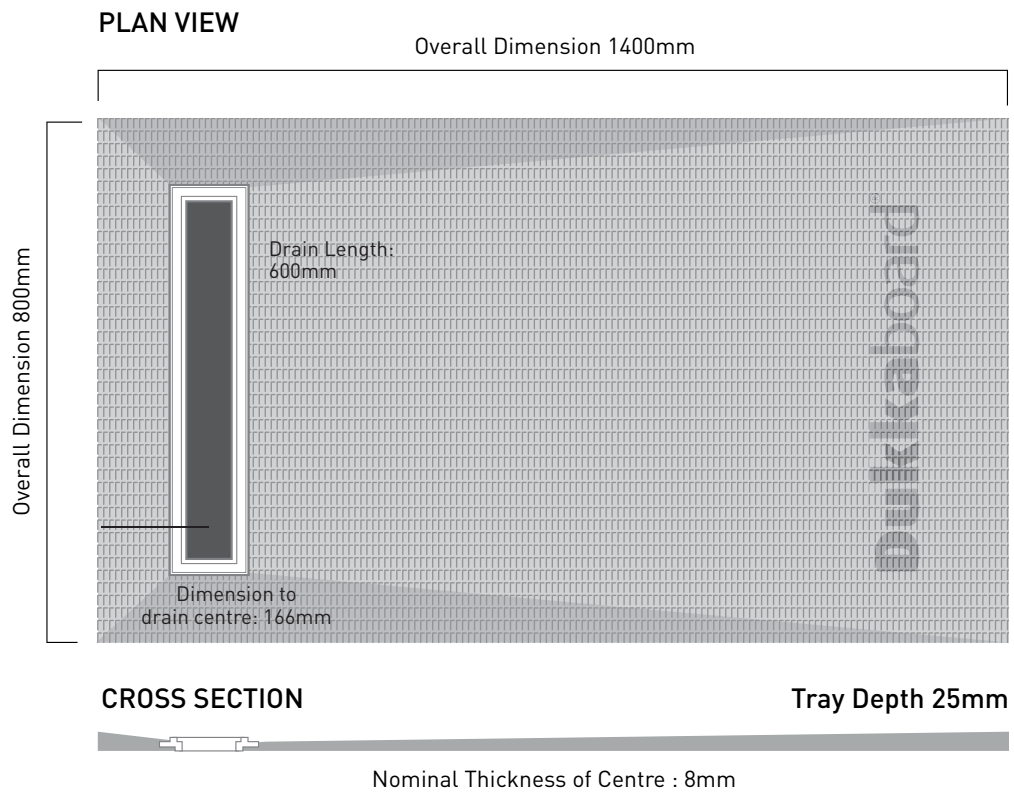

### Dukkaboard

Tel: 0870 1271 300  
 Email: [info@dukkaboard.com](mailto:info@dukkaboard.com)



For technical information, support and more installation guides and videos from the expert team at Dukkaboard, visit [www.dukkaboard.com/the-knowledge-network](http://www.dukkaboard.com/the-knowledge-network)

[www.dukkaboard.com](http://www.dukkaboard.com)

# Dukkaboard®

## DUKKABOARD SHOWER TRAYS

Document number DTD-1035	Revision 1.1
Standard Dukkaboard Tray 1650 X 1000 X 30mm O/S	Product Code DS-ST-0010 / 0025
To Suit Drain Dukkaboard Channel E-Drain	Date 08/09/2017

### PLAN VIEW

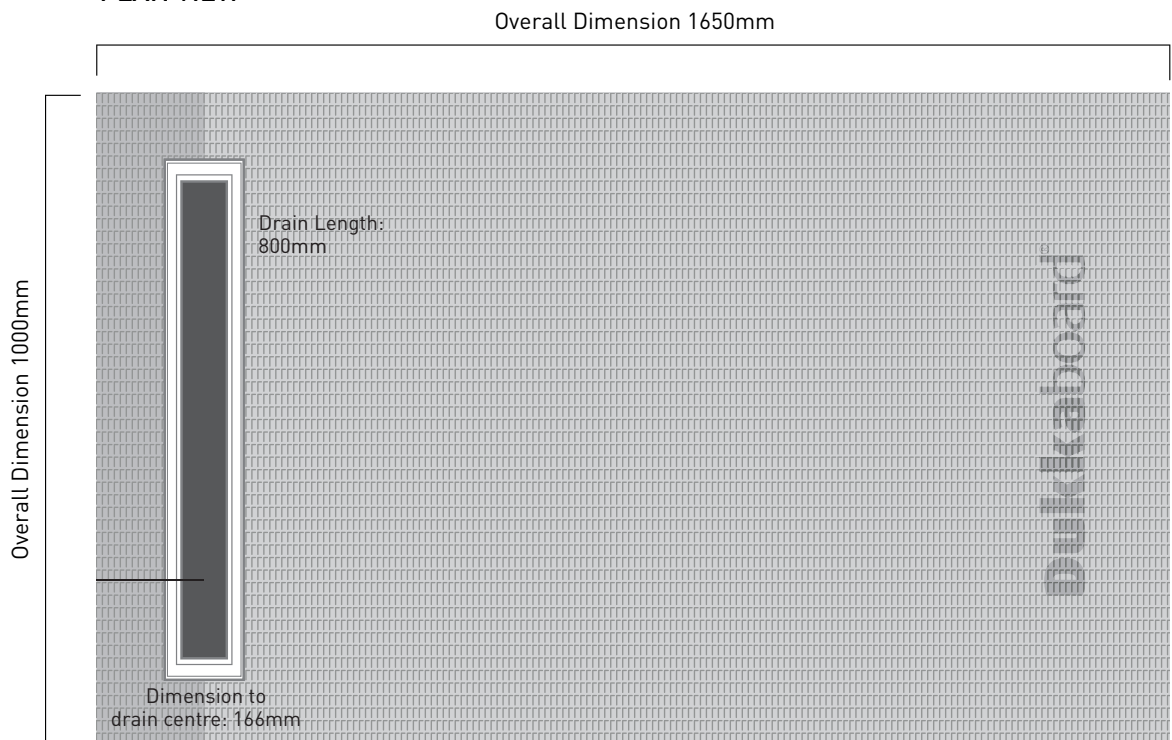

### CROSS SECTION

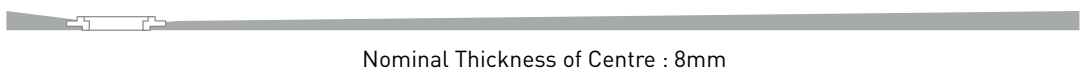

### Dukkaboard

Tel: 0870 1271 300  
 Email: [info@dukkaboard.com](mailto:info@dukkaboard.com)



For technical information, support and more installation guides and videos from the expert team at Dukkaboard, visit [www.dukkaboard.com/the-knowledge-network](http://www.dukkaboard.com/the-knowledge-network)

[www.dukkaboard.com](http://www.dukkaboard.com)

## DUKKABOARD SHOWER TRAYS

Document number DTD-1036	Revision 1.1
Dukkaboard Shower-Trap	Product Codes DS-ST-0010 / 0025
To Suit Dukkaboard Shower-Trays	Date 07/09/2016

### HORIZONTAL DRAIN KIT

DS-ST-0010

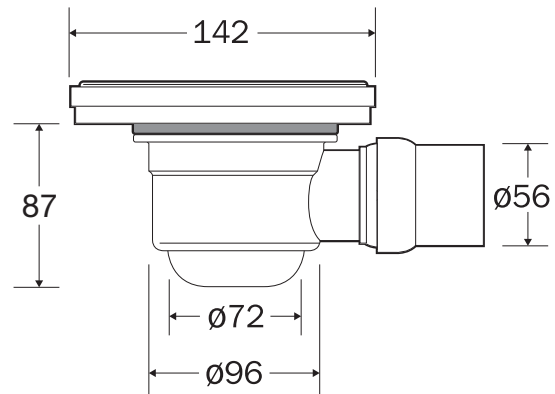
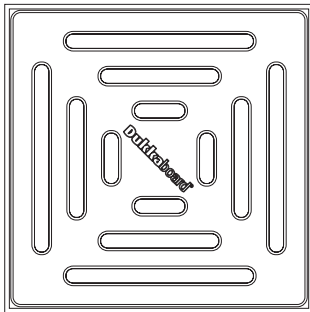

### VERTICAL DRAIN KIT

DS-ST-0025

